

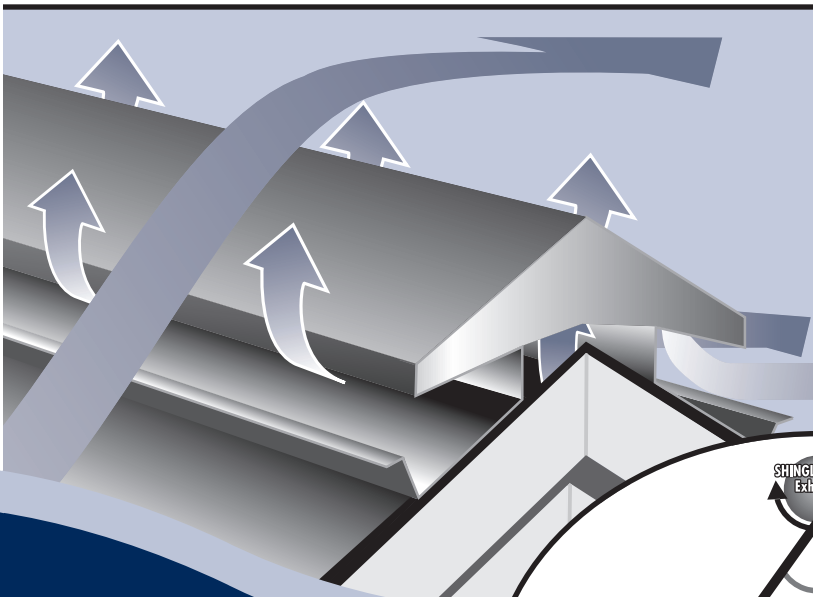

Principles of Attic Ventilation

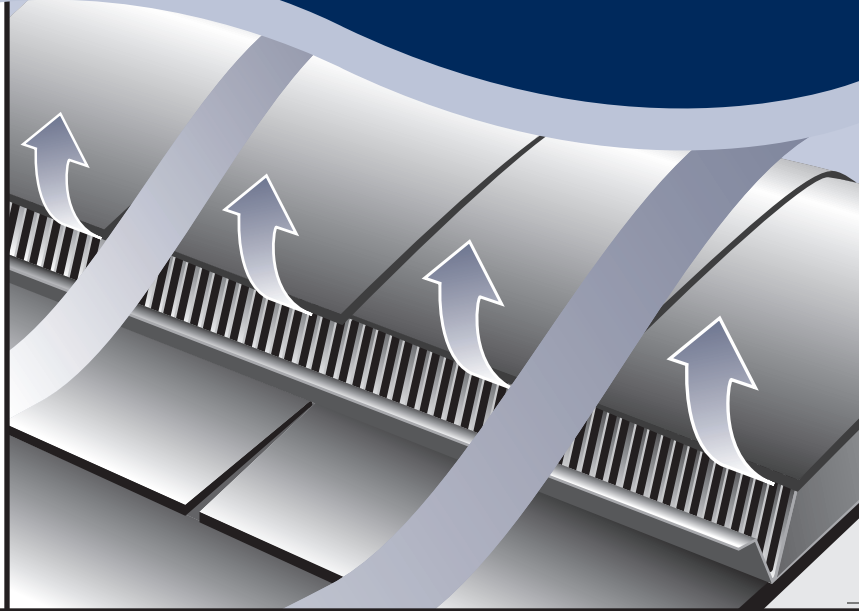

A comprehensive guide to planning The Balanced System™ for attic ventilation

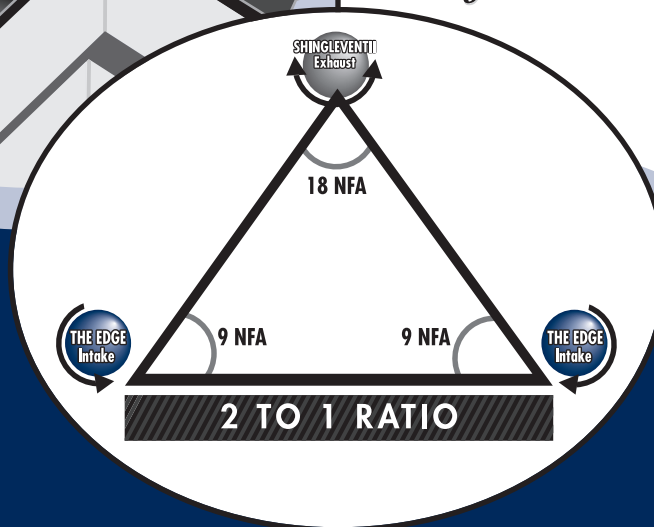



Introduction: The Year-Round Benefits of Proper Attic Ventilation	1
Section 1: How Ventilation Works	5
Section 2: Types of Vents	7
Section 3: Determining Attic Ventilation Requirements for The Balanced System™	13
Appendix: Ridge Vent/Intake Vent Calculator	15
Glossary: Glossary of Terms	inside back cover

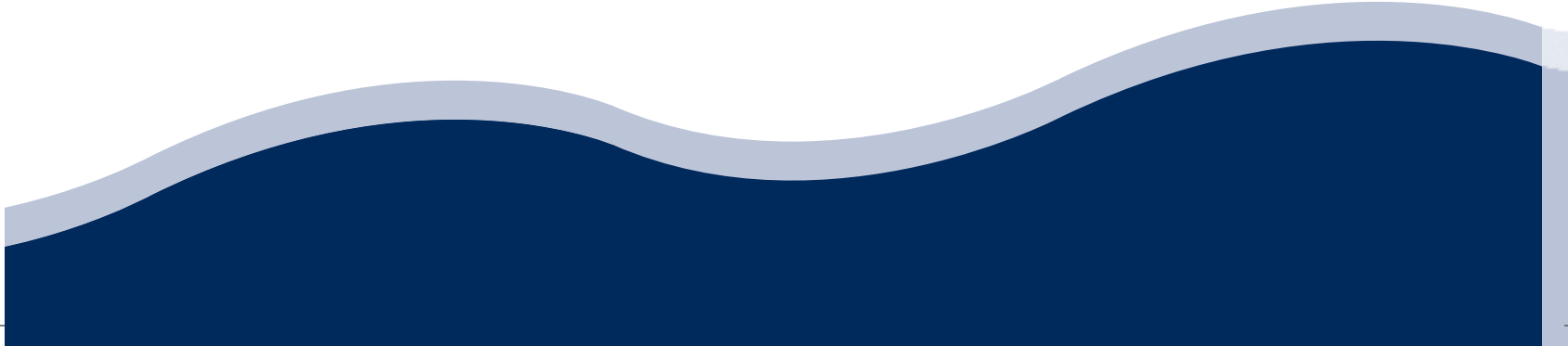

Introduction: The Year-Round Benefits of Proper Attic Ventilation

What's the purpose of attic ventilation? It seems like a simple question, easy enough to answer. Unfortunately, all too often, that's not the case. Most homeowners – and even some experienced builders and contractors – believe the purpose of attic ventilation is to remove heat that builds up in the summer.

That's accurate, of course. But what that answer leaves out is just as important as what it includes.

If you understand the principles of attic ventilation, you know an effective venting system provides year-round benefits.

- During warmer months, ventilation helps keep attics cool.
- During colder months, ventilation reduces moisture to help keep attics dry. It also helps prevent ice dams.

We can make that answer more specific – and more meaningful – by translating those functional descriptions into a list of benefits:

Several purposes of an attic ventilation system are to provide added comfort, to help protect against damage to materials and structure, and to help reduce energy consumption – during all four seasons of the year.

Your goal should be to provide those benefits whenever you design and install an attic ventilation system. The rest of this booklet will show you how.

Ventilation During Warm Weather

Dealing with the effects of heat. Why, on a hot day, are the upper rooms of a home always warmer?

Part of the answer, of course, is simple physics: hot (lighter) air rises while cooler (denser) air falls. But in most homes – the vast majority of homes without adequate attic ventilation – a far more important factor comes into play: the downward migration of heat.

Consider what happens in such a home on a typical summer day (see Figure 1). Radiant heat from the sun hits the roof. The roof temperature increases and heat travels (technically, it conducts through the roof sheathing) into the attic. As heat builds up in the attic, it radiates to the attic floor, then into adjacent living areas, raising temperatures there.

You appreciate the effects of that process when you look at the temperatures involved. These are typical temperatures for a home with no attic ventilation, on a sunny day, with an outdoor temperature of 90°F (32°C).

- Temperature at roof sheath: as high as 170°F (77°C).
- Temperature at attic floor: up to 140°F (60°C).
- Temperature in rooms directly beneath attic: uncomfortable.

Of course, the longer these hot, sunny conditions last, the more uncomfortable it becomes in the home. That's because an unventilated – or inadequately ventilated – attic seldom loses enough heat overnight to compensate for the heat gained during the day. Ironically, the effect is magnified in modern homes with heavier insulation (see the “insulation/ventilation connection” on page 2).

Eventually, this accumulation of heat begins to have more practical – and costly – consequences.

The most obvious are the actions taken by homeowners to cool themselves. To reduce the effect of the heat – not only the daytime heat gain but also the excess heat being stored in the attic – they turn on fans, window air conditioners or central air conditioning systems. As the hot weather continues, these appliances run longer and longer – a fact well documented by utility companies across the country. Homeowners pay for all this added energy consumption in higher utility bills.

A less obvious – but equally costly – consequence can be found on the roof itself. Homeowners can't see it happening, but over time excess attic heat can cause some shingles to distort and deteriorate. The result is premature failure of roofing materials – and perhaps a leaky roof. Once that happens, the cost of a new roof is the least homeowners can expect to pay. More than likely, they also may face added costs for structural and interior repairs related to water infiltration.

Figure 1

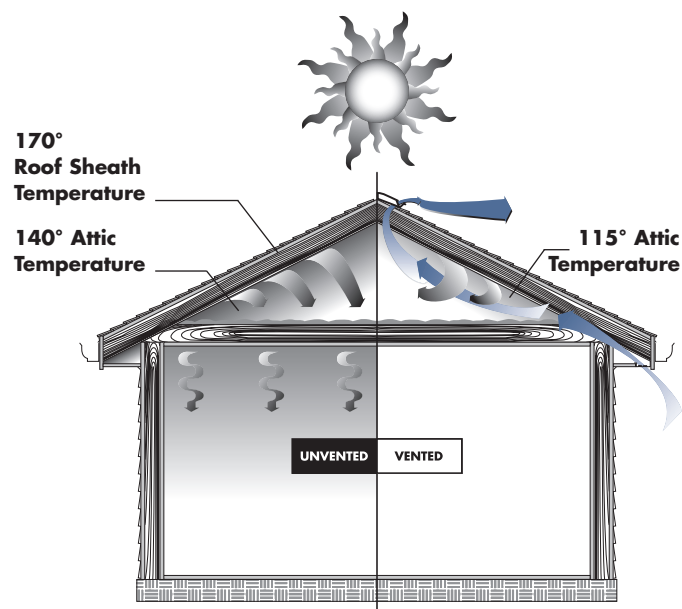

Unvented: Radiant heat penetrating through roof sheath and attic enters living areas of home.

Vented: With proper ventilation the heat is vented out of the attic keeping living areas cooler.

2 Introduction: The Year-Round Benefits of Proper Attic Ventilation

The insulation/ventilation connection.

Efficient insulation increases the need for effective ventilation. Why? Because heavier insulation absorbs and holds more heat. That means it's less likely overnight cooling can remove heat that builds up in an attic during a prolonged period of hot, sunny weather.

The solution to this dilemma isn't to reduce the insulation in an attic. That would only create problems at other times of the year. Instead, the goal is to design an attic ventilation system that effectively compensates for the additional heat gain produced by the high levels of insulation.

In short, effective attic ventilation also helps cool attic insulation.

How ventilation helps solve attic heat problems.

Ventilation can't eliminate the transfer of heat from roof to attic, but it can minimize its effect. To do that, a well-designed system must provide a uniform flow of cool air along the underside of the roof sheathing. That steady flow of air carries heat out of the attic before it can radiate to the attic floor.

It's critical that this airflow is uniform. That means intake and exhaust vents must be balanced – for both position and airflow capacities. Otherwise, “hot spots” can develop under roof sheathing, drastically reducing the efficiency and effectiveness of whatever ventilation is installed.

Ventilation During Cold Weather

Dealing with the effects of moisture buildup. When winter arrives and temperatures plunge, you might think the movement of heated air would no longer cause problems in attics. But that's not true. With seasonal changes, the conditions just reverse. Heat doesn't travel from an attic into the living quarters. Instead, heated indoor air travels from the home into the attic – along with moisture.

Figure 2 illustrates how this process of moisture transfer takes place. Furnace-warmed air circulates through the house, picking up water vapor generated by activities such as cooking, bathing, and the washing of clothes and dishes. The use of humidifiers, common in many homes, provides an abundant and continual source of moisture. Keep in mind also that the warmer the air is, the greater its capacity to hold moisture.

The problem is especially acute in homes with electric heating. Most of these homes were built since the mid-1970s, using advanced insulation materials and methods. As a result, most are “tight,” allowing minimal infiltration of outside air. In addition, electric heat sources do not require air for combustion, so another common source of outdoor air has been eliminated. The positive side of these super-insulated homes is, of course, the greater energy efficiency. But because cooler, drier outdoor air is kept out, the indoor air holds greater amounts of moisture.

Problems arise when the warm, moist air from the living quarters moves toward the attic, where the air is cooler and drier. That moist air is drawn to the attic in two ways. The first is through a process called “vapor diffusion.” It's a process in which water vapor naturally travels from high-humidity conditions to low-humidity conditions – in our example, from the living quarters into the attic. The force of vapor diffusion is so great that moisture even travels through building materials such as sheet rock.

Figure 2

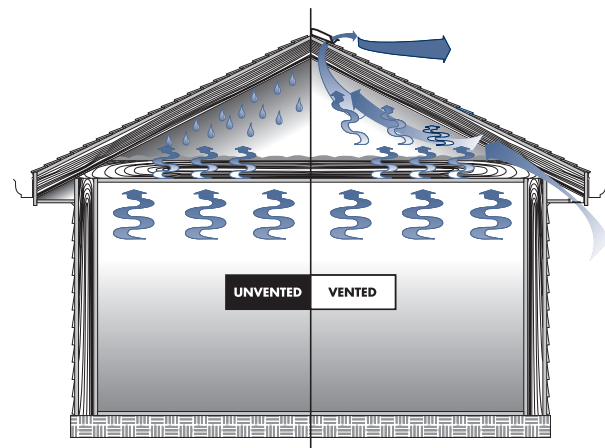

Unvented: Moisture rising up through the house condenses in the attic, causing damage to studs, insulation, and other materials.

Vented: A vented attic allows moisture to escape.

Even vapor barriers, for all their effectiveness, cannot totally stop this process. The second way moisture travels into an attic is by air moving through openings cut into a vapor barrier. Such openings are commonly found, for example, at recessed ceiling boxes and attic entries.

The problems start when moist air hits cooler rafters, trusses and roof sheathing. The moisture condenses as water droplets or frost. Eventually, the condensation drips on the insulation below. If too much water soaks into the insulation, its volume can be compressed and its effectiveness reduced. The sequence of events that follows is predictable: greater heat loss leads to colder rooms, colder rooms lead to a greater need for heat, greater use of the furnace leads to higher energy bills.

But that's only the immediate problem and its consequences. As with heat buildup, moisture buildup has long-term effects. That's because not all the condensing moisture drips into insulation. The structural elements of the house absorb some, leading to wood rot and the deterioration of roofing materials. Other moisture is likely to soak into the attic floor and eventually into ceiling materials, causing water stains and paint damage in the rooms below.

How ventilation helps solve attic moisture problems.

Although the problems of attic heat and moisture have different causes, they share a common solution: a high-efficiency ventilation system that allows a uniform flow of air to sweep the underside of the roof sheathing. In warmer months, such a system exhausts hot air from an attic; in the colder months, it exchanges warm, moist air with cooler, drier air. In both cases, the result is the same: less damage to a home.

Dealing with the effects of ice dams. Winter creates a special attic ventilation problem in areas where snowfall and cold temperatures are common occurrences. The problem begins with the formation of ice dams – literally barriers formed of ice – that prevent melt water from running off a roof. (The map in Figure 3 shows areas of the U.S. where average winter conditions can lead to the formation of ice dams.)

Figure 3 Areas of snowfall in the U.S.

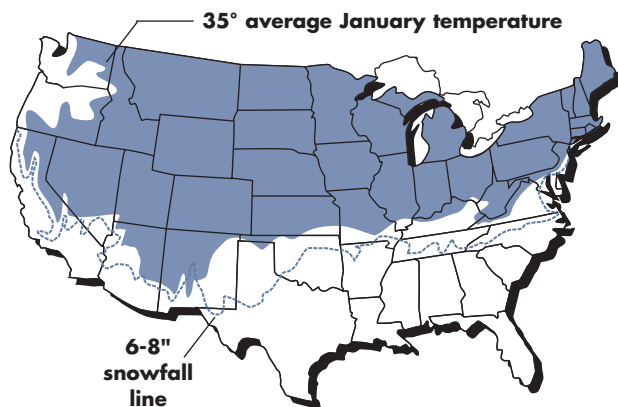

Above the 6-8" snowline concern should be given to the prevention of ice dams forming on the eave of the roof.

Ice dams can form when the following conditions exist:

- **Warm air accumulates near the peak of an attic.** This condition is much more common than people think. It occurs because most attics experience some heat loss from attic insulation. And because warm air rises, the upper portion of an attic is always the warmest. Normally, that pocket of warm air won't result in problems – that is – until the following conditions are met.
- **Lower areas of the roof remain cold.** Once again, this is a common condition, especially in the area just above the eave, where temperatures may not be much higher than the ambient outdoor air. If the outdoor temperature is well below freezing, conditions are favorable for the formation of an ice dam.

- **A heavy snow cover accumulates on the roof.** This snow accumulation not only provides the necessary moisture, it also acts as a layer of insulation, preventing heat loss through the roof sheathing. As a result, temperatures in the attic are typically warmer than they are on days when the roof is free of snow.

When all three conditions are met, ice dams form quickly. Heat high in the attic causes snow to melt near the roof peak. The water from the melting snow flows toward the eave area, where colder roof temperatures allow it to refreeze. If conditions persist over several days, this re-freezing of snow melt can form an ice dam (see Figure 4).

The weight of the dam itself can damage gutters and fascia. When it eventually falls, it also can damage structures or shrubbery below. But the greatest damage occurs when the water pooling inside the dam begins to infiltrate under shingles. The shingles themselves are damaged – if not destroyed. Far more serious, however, is the damage caused at the plateline area. Insulation can be soaked, reducing its effectiveness. Plus water can infiltrate into both exterior and interior wall cavities, leading to structural damage and the deterioration of painted surfaces. At the very least, mold and mildew can form, creating unpleasant odors and mold spores, resulting in poor indoor air quality.

Figure 4

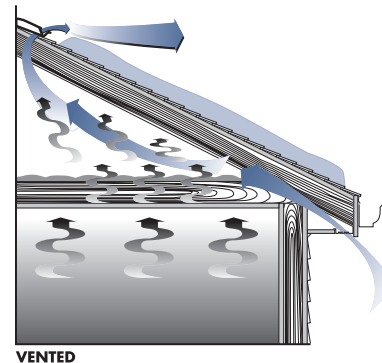
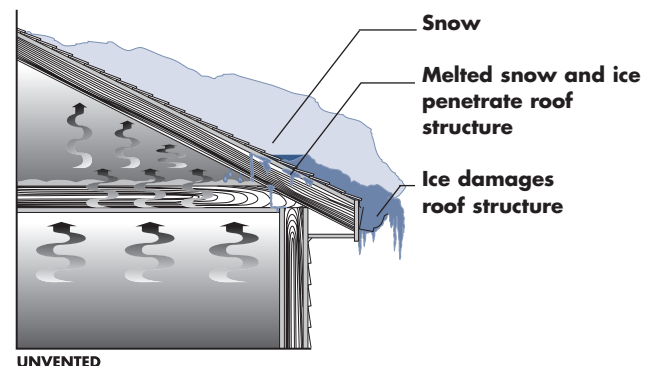

Unvented: Heat entering attic from the home melts the snow on the roof and forms destructive ice dams.

Vented: Heat is vented out of the attic creating a cold roof.

4 Introduction: The Year-Round Benefits of Proper Attic Ventilation

How ventilation helps solve ice dam problems. When homeowners set out to eliminate ice dams, their typical response is to add more insulation to attics. But no amount of insulation, if used alone, can eliminate the formation of ice dams. An efficient attic ventilation system must be part of any solution.

A properly designed ventilation system creates a “cold roof” – a condition where the roof temperature is equalized from top to bottom. An equalized roof temperature, in turn, helps eliminate the conditions that lead to the formation of ice dams (see Figure 5).

By now you probably know how ventilation creates a cold roof: it allows a flow of air to sweep along the underside of the roof sheathing, minimizing temperature differences. By now you also may have a valid question to raise: Aren't we talking about a uniform flow of cold air sweeping through the attic?

Exactly, and that's why ventilation alone isn't a complete solution either. For maximum comfort, reduced structural damage and optimum energy conservation, ventilation must be used with a waterproofing shingle underlayment and, of course, with insulation. Ample insulation¹ is required to minimize heat losses, and high-efficiency air movement is required to remove any heat that enters the attic (Figure 6 illustrates insulation recommendations based on geographic zones.)

Figure 5

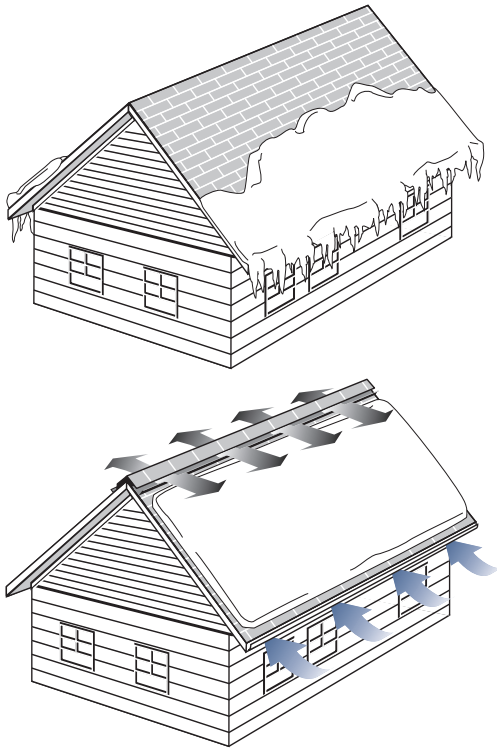

Top: Ice dams, besides being unsightly, are destructive.

Bottom: Vented attic with snow melting evenly is much more desirable.

A defense against ice dams

To reduce the possibility of ice dams, use a three-step approach:

1. Install adequate attic ventilation. Because ice dams form when a roof has warm upper surfaces and cold lower surfaces, the solution is to equalize temperatures over the entire roof. The most effective way to equalize temperatures is to create a cold roof.

To do that, you need a well designed attic ventilation system that will supply airflow along the entire underside of the roof deck. That's critical, because only a uniformly distributed airflow can reduce variation in roof temperatures from peak to eave.

One of the most efficient and effective systems (from both cost and performance standpoints) uses ridge vents and an evenly distributed layout of intake vents.

2. Install adequate attic insulation. Attic insulation serves two purposes. First, it reduces heat loss from a home's living quarters. Since that heat loss is a key factor contributing to the creation of ice dams, stopping it at its source is critical. Second, adequate attic insulation diminishes the energy impact of having cold air flowing through the attic.

When installing insulation – or checking existing insulation – be sure to install adequate amounts around electrical fixtures and wiring and plumbing chases. These areas often contribute to significant heat loss. With existing insulation, also check for water damage and for areas compressed by foot traffic or stored objects. Finally, make certain existing insulation meets today's R-Value requirements.

3. If possible, install waterproofing shingle underlayment (WSU). Even the most efficient attic ventilation system may not be enough to eliminate all ice dams. A combination of weather conditions, roof pitch, building orientation and other factors may allow ice dams to form under certain conditions. If that happens, a WSU barrier can minimize – and possibly eliminate – water infiltration into the building structure (see Figure 7).

Install WSU according to the manufacturer's instructions. In general, install WSU at least two feet above the interior wall line; many contractors say a three-foot barrier is even better. When working in valleys, install WSU three feet on each side of the valley center (see Figure 8).

¹ It's difficult to say precisely how much insulation will be required. Many factors, from house design to its orientation to the weather, enter into the equation. A good rule of thumb, however, is to provide at least 10 to 12 inches of insulation. That's equivalent to an R-Value of 38.

Figure 6

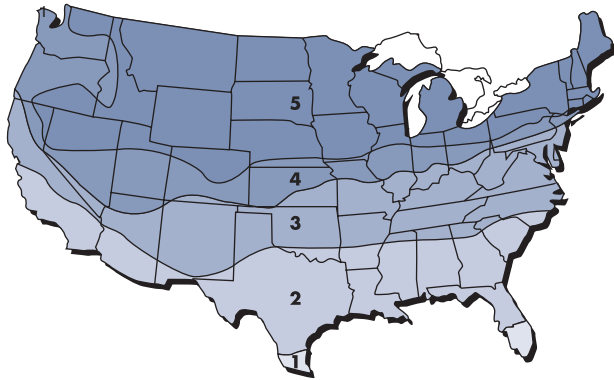

Thermal Recommendations

Winter Heating Plus Summer Cooling

Zone	Ceiling Insulation R-Value	Wall Insulation R-Value	Floor Insulation R-Value
1	R-19	R-11	R-11
2	R-30	R-19	R-11
3	R-38	R-19	R-13
4	R-38	R-19	R-19
5	R-49	R-19	R-25

Figure 7

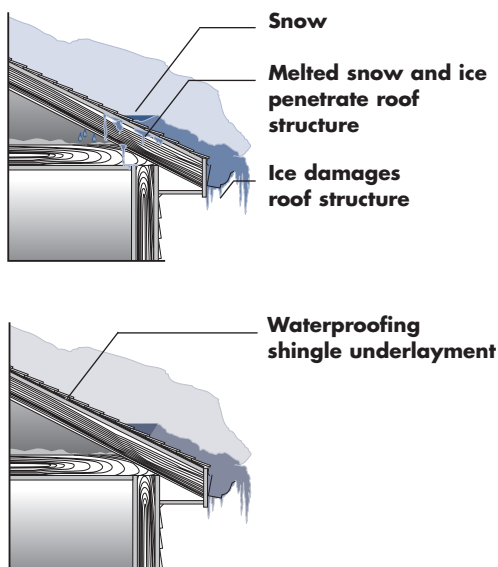

(Top) Water can penetrate to an unprotected roof sheath causing the roof sheath to rot.

(Bottom) Waterproofing shingle underlayment helps prevent water from penetrating to the roof sheath.

Figure 8

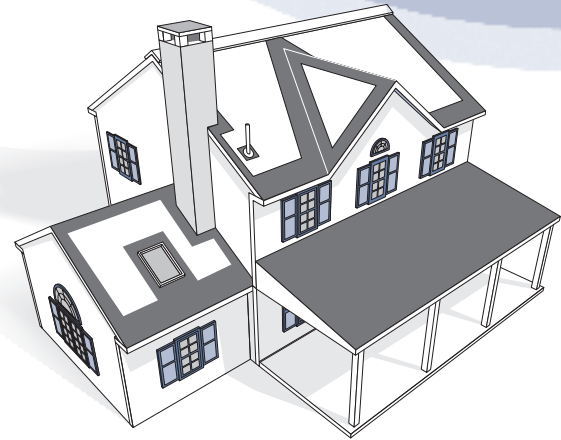

The dark shaded areas are the places that waterproofing shingle underlayment helps protect from the melting water coming off the ice dam.

Section 1: How Ventilation Works

“Ventilate” comes from the Latin word for “to fan,” the action of causing air to move.

And that’s exactly how ventilation works: it provides the conditions that allow air to move.

For our purposes, however, we have to get a little more technical, because efficient ventilation requires a very specific type of air movement. We’re not interested in moving air just to create a breeze that cools us by speeding evaporation. Instead, we want ventilation that provides year-round benefits.

If you’ve ever walked into the stuffy confines of a room that’s been completely closed for a lengthy period, you know air tends to stay in place. You also know that just opening a door or window doesn’t solve the problem immediately. A flow of air must be established to produce the air changes needed to remove all the stale air.

That’s what an efficient ventilation system must do, too – provide a steady, high volume of air movement. That means the system components must be sized and positioned to provide a constant flow of air, moving in a constant direction.

We can create air movement in one of two ways – using natural ventilation or mechanical ventilation.

6 Section 1: How Ventilation Works

Using natural ventilation. Natural air movement is created by two key forces: thermal effect and wind (see Figure 9).

Figure 9

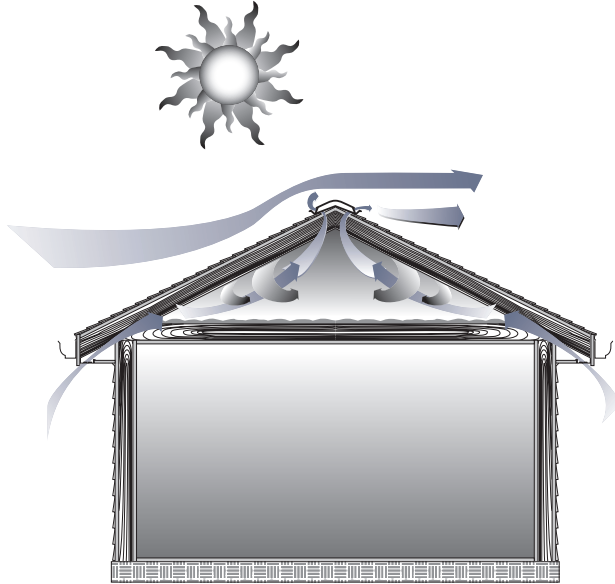

Thermal Flow (effect whereby cooler air falls, warmer air rises) and Natural Flow (effect due to wind) come together to ventilate an attic.

Thermal effect. We've already mentioned thermal effect briefly. It's the inherent property of warm air to rise. A well-designed system takes advantage of that movement in two ways:

First, since warm air rises, an effective system will include exhaust vents at or near the ridge. That placement allows the hottest air to be removed from the attic most efficiently.

Second, the thermal effect creates a natural circulation of air, because as warm air rises, cooler air falls. A well-designed system assists this momentum by placing intake vents at the lowest point in the attic, typically in the soffit or near the roof's edge. The cooler air entering these vents (cooler as compared to the attic air) speeds this circulation of air.

Wind. By itself, however, thermal effect cannot create the high volume of air movement needed for effective ventilation. That's why the influence of wind is the key element in the design of a non-powered ventilation system. Wind, after all, is a natural flow of air. So when designing a ventilation system, you want to make the wind work to your advantage.

To use the power of wind, you have to understand how wind force affects ventilation. It isn't the velocity of the wind by itself that causes air to move through an attic. Instead, it's the wind's speed as it moves against and over

a home's exterior surfaces. A wind-driven flow of air creates areas of high and low air pressure (see Figure 10). High pressure forces air into the attic, while low pressure draws air out.

Figure 10

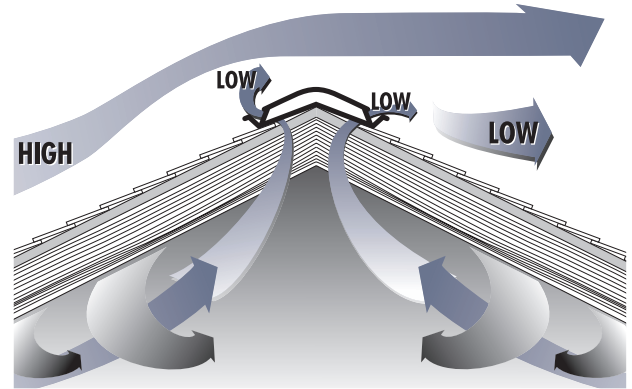

Wind passing over the baffled ShingleVent® II ridge vent creates a low pressure area at the vent's openings which causes air to be lifted or pulled out.

The Balanced System™. A properly designed ventilation system requires balance. That balance is achieved in two ways:

- 1) Airflow capacity must be balanced between intake and exhaust vents. In general, the net free area² of intake venting should be equal to or greater than the net free area of exhaust venting. To determine how much net free area a particular home requires, see Section 3.
- 2) Intake and exhaust vents must be positioned to create a proper high-low balance. That balance is achieved when two conditions are met:
 - a) Half the vent area must be high in the attic, with the other half low in the attic. Without that balance, the area of effective ventilation is limited to the lesser of the two vent areas. For example, if 75 percent of the venting is high and 25 percent low, ventilation is limited to the air moving through the lower vents.
 - b) The vents placed high must act as exhaust vents, while the low vents act as intake vents. That placement assures a continuous flow of air, moving in the desired direction.

² Net free area means the total unobstructed area (usually measured in square inches) through which air can enter or exhaust a non-powered ventilation component.

In planning the location of intake and exhaust vents, two other factors must be considered:

- 1) Intake and exhaust vents must be positioned so they assure continuous airflow along the underside of the roof sheathing. As we learned in the introduction, this is where ventilation is most effective. During summer, airflow along the sheathing removes heat before it can radiate to the attic floor. During winter, airflow along the sheathing removes moisture before it can condense into water droplets or frost.
- 2) Intake vents must be located so there is little possibility of rain or snow infiltration. Conventional intake products require installation in the soffit (area underneath the eave of the house) for maximum weather protection. However, there is now a product that allows roof-top installation and maximum weather protection – The Edge™ Vent (see Figure 11).

Figure 11

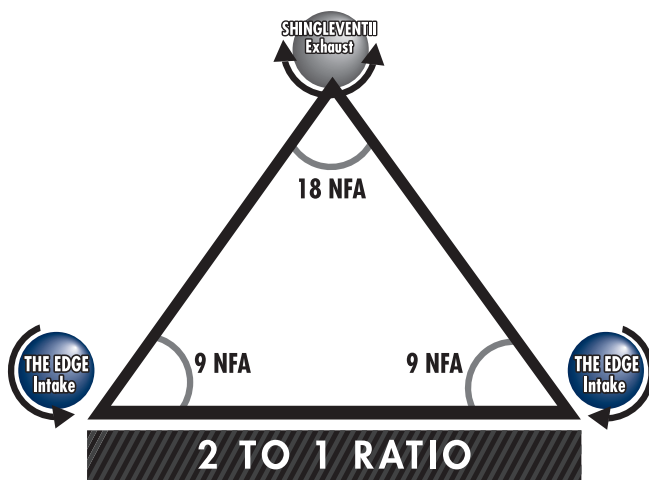

To work most efficiently the attic ventilation system must be balanced between intake and exhaust vents. An easy way to achieve The Balanced System™ is with ShingleVent®II shingle-over ridge vent for exhaust and The Edge™Vent shingle-over intake vent.

Section 2 discusses the various types of exhaust and intake vents. Section 3 includes sample calculations for The Balanced System™.

Figure 12

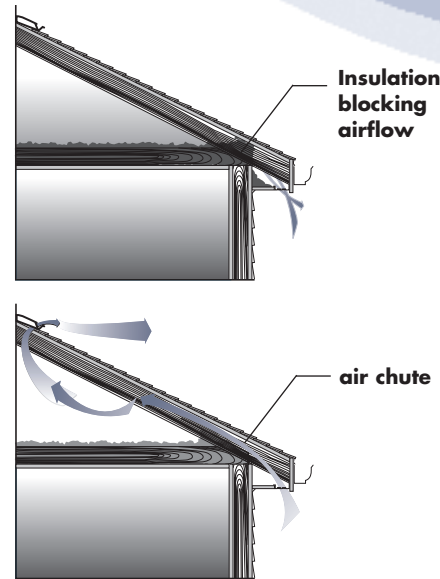

(Top) Insulation blocks undereave intake vents preventing proper airflow into the attic.

(Bottom) An unblocked undereave vent allows a passage for air to move through attic.

Note: To assure optimum performance of intake vents, you must make certain the area above the intake opening isn't blocked by dirt, building debris or attic insulation.

Section 2: Types of Vents

In describing how ventilation works, we discussed intake and exhaust vents in general terms, perhaps giving the impression that a single type existed to serve each function. In fact, however, you can choose from a wide range of intake and exhaust components, allowing you to tailor ventilation systems to the specific characteristics of every home.

In general, ventilation components can be divided into two broad categories: intake vents and exhaust vents. Within each category there are various styles. Furthermore, ventilation components are either fixed (also called static) or powered.

Fixed ventilation

Fixed ventilation components are exactly that: units that don't require moving parts or power assistance for proper functioning. But don't let that description lead you to believe fixed ventilation is a low-tech alternative to high-efficiency systems. Just the opposite is true. Fixed ventilation components form the core of all attic ventilation systems, from the simplest to the most sophisticated. In fact, in most cases, your initial goal should be to try to design a ventilation

8 Section 2: Types of Vents

system that uses only fixed vents (or ridge vents – a special, high-efficiency type of fixed ventilation).

Obviously, since fixed ventilation can be used to create an entire system, units are available for both intake and exhaust functions.

Intake vents. Intake vents are available in many designs. In choosing the right unit for a particular job, you have to consider the structure of the home, the area where the units will be located and the net free area provided by each unit.

The most common types of intake venting are:

Undereave vents which are mounted in soffit. Units vary in size from 16" x 8" to 16" x 4". Naturally, net free area varies according to unit size (see Figure 13).

Continuous soffit vents which are also mounted in the soffit. These units vary in length, with the typical length being 96" (see Figure 14).

Vented drip edge which is used on homes without an eave area (see Figure 15).

The Edge™ Vent shingle-over intake which is a roof-top installed vent available in 4' lengths (see Figure 16).

Mini-louvers which are typically used with other types of intake venting; they're too small by themselves to provide sufficient net free area of intake. In most applications, they're installed in an exterior wall to help eliminate moisture that collects in the wall cavity. To be effective, mini-louvers must be installed below the source of humidity (such as a bathroom or laundry area). That placement allows a flow of air to collect the humidity and carry it into the attic.

Figure 13

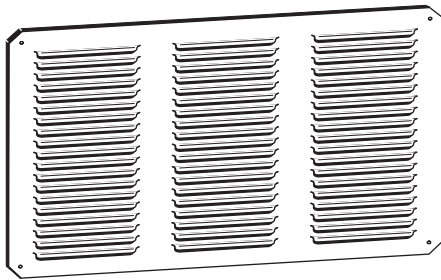

The undereave vent, an intake vent, allows needed air to enter the attic. It is located on the underside of the eave of the house.

Figure 14

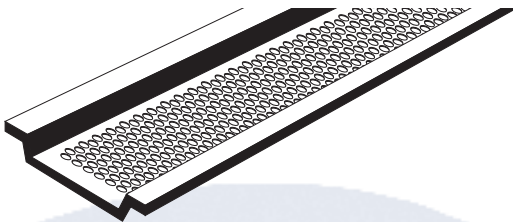

Continuous soffit vent takes in outside air and is located on the underside of the eave.

Figure 15

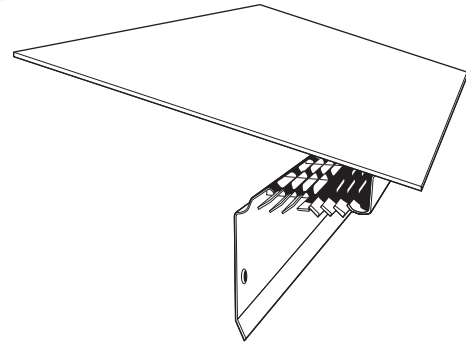

For soffitless applications vented drip edge combines a drip edge with intake louvers.

Figure 16



While conventional intake vents require installation in the soffit for maximum weather protection, the shingle-over intake vent The Edge Vent has been designed for roof-top installation and maximum weather protection.

Exhaust vents. Exhaust vents are designed to permit an efficient, unobstructed outflow of attic air. In addition, because they're installed high in the attic where there's greater exposure to the weather, these units must be designed to prevent (or at least minimize) rain and snow infiltration.

Exhaust vents must be used with intake vents to provide a balanced system and thus an adequate flow of air through an attic. It's also worth repeating another point made previously: for maximum efficiency, the net free area of intake vents should be equal to or greater than the net free area of exhaust vents.

As with intake vents, exhaust vents are available in different designs. Two commonly used fixed exhaust vents are:

Roof louvers which are installed as close to the roof ridge as possible to allow maximum release of moisture and overheated air. Because they're installed near the ridge, they provide a continuous airflow along most of the underside of the roof sheathing. The airflow pattern isn't

uniform, however, so for maximum effectiveness, vents should be spaced equally along the roof (see Figure 17).

Figure 17

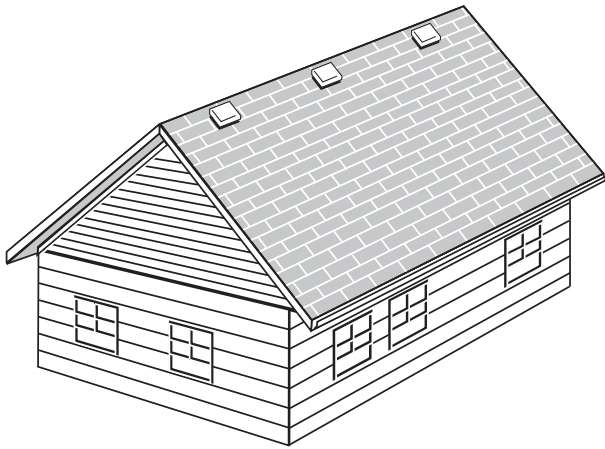

A roof louver is an exhaust vent located near the ridge.

Gable louvers which are typically installed in the gables. Two types are available: rectangular and triangular. In most installations, a unit is placed at each gable end (see Figure 18).

Figure 18



A gable louver, an exhaust vent, allows unwanted air to flow out of the attic. These are located at the ends of the attic.

Note: Sometimes louvers are installed in opposite gable ends, without intake venting, in the mistaken assumption that a good “cross flow” of air can provide adequate ventilation. What typically happens, however, is illustrated in Figures 19 and 20. If wind direction is perpendicular to the ridge, the louvers act as both intake and exhaust vents, providing ventilation only in the areas near the vents. If the wind direction is parallel to the ridge, a cross flow of air is established, although the flow tends to dip toward the attic floor, leaving the hottest air still at the underside of the roof sheathing. Of course, if

absolutely no intake venting can be installed at low points in the attic, a louver-only installation is preferable to no ventilation at all.

Figure 19

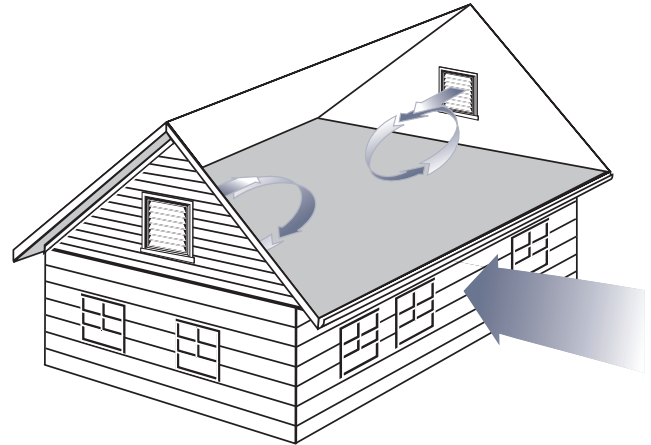

With wind blowing perpendicular to the ridge, the louvers act as both intake and exhaust vents.

Figure 20

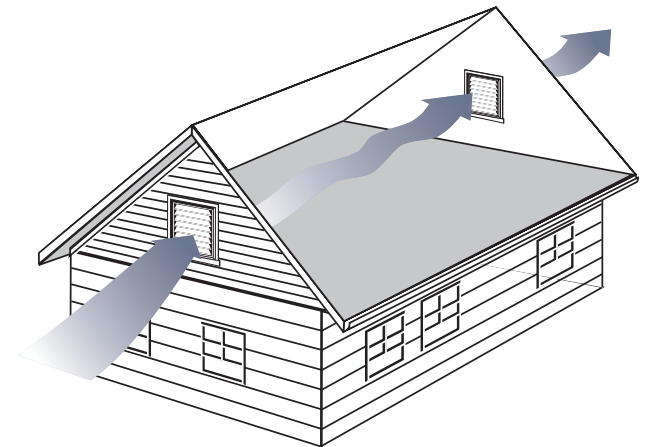

With wind blowing parallel to the ridge, airflow dips towards the attic floor leaving the hottest air still on the underside of the roof sheathing.

Ridge vents

As mentioned above, ridge vents are a special type of fixed exhaust venting. That distinction is warranted, because ridge vents offer unique advantages when compared to other fixed venting units. Those advantages include:

- **Maximum efficiency.** The best ridge vents use an external baffle designed to draw heated air from an attic regardless of wind direction or force. Figure 21 shows how that happens.

Figure 21



A baffled ridge vent creates an area of low pressure on both sides of the ridge vent. It literally pulls air out of the attic.

When wind direction is perpendicular to the ridge, it strikes the external baffle and jumps over the ridge. That movement creates a Bernoulli effect, causing low pressure to develop on both sides of the vent. When that happens, air from the attic is “lifted” out, in much the same way low pressure created above an airplane wing gives “lift” to the plane (refer also to Figure 10 on page 6).

The same thing happens when the wind direction is parallel to the ridge. It moves across the louvers, creating low pressure areas at the louvers on both sides of the ridge vent.

In addition, when little wind force exists, ridge vents take full advantage of the thermal effect to maintain air circulation across the underside of the roof sheathing. Warm air rises to the ridge and exhausts through the vent. That allows a continuous flow of cooler air to enter through the intake vents. Only ridge vents use thermal effect efficiently and effectively, because only ridge vents provide continuous and uniform air movement along the full length of a roof.

Note: To provide this efficient air movement, ridge venting should be balanced with equal net free area of intake venting. For best results, intake venting should be divided equally along both sides of a structure. An easy way to achieve The Balanced System is with ShingleVent II shingle-over ridge vent for exhaust and The Edge Vent shingle-over roof-top intake vent.

– **Maximum air movement.** Externally baffled ridge vents work better because they take advantage of two natural forces: thermal effect or the fact that warm air rises and low air pressure that is created at the vent openings as wind is deflected by the baffle. (see Figure 10 on page 6).

– **Uniform air movement.** Because ridge vents run the entire length of a roof, they provide a uniform flow of air along the underside of the roof sheathing. That air movement helps eliminate “hot spots” that can develop with other types of exhaust vents – even powered vents. No other exhaust vent provides this type of airflow pattern.

– **Maximum visual appeal.** Most ridge vents offer a low-profile design that minimizes their appearance on a roof. Shingle-over designs allow optimum blending with other roof materials (see Figure 22 and Figure 23).

Figure 22

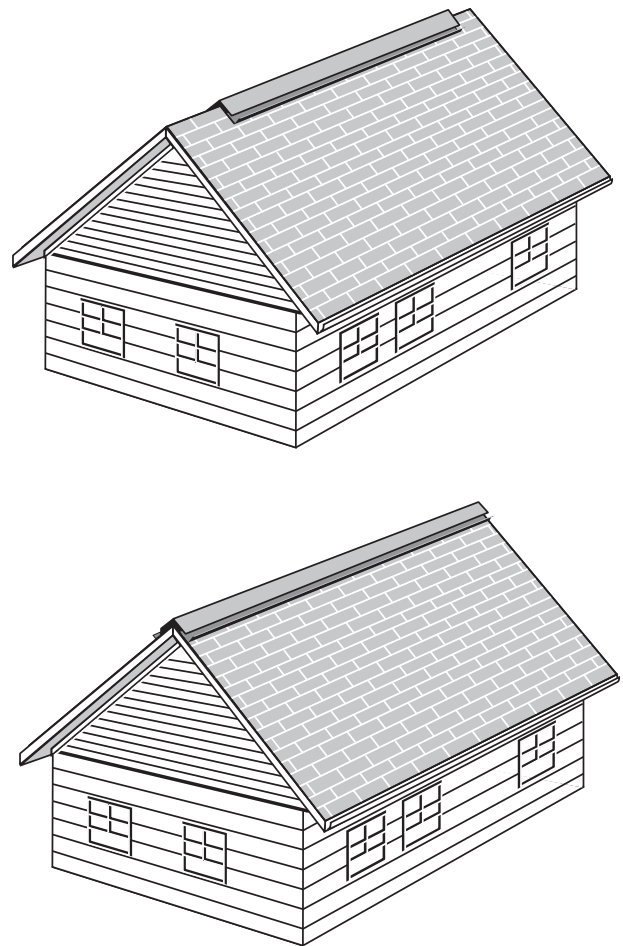

(Top) Ridge vent installed shorter than the ridge length presents an awkward “broken” appearance.

(Bottom) A ridge vent should extend all the way along the roof for a smooth “unbroken” roof line.

Figure 23

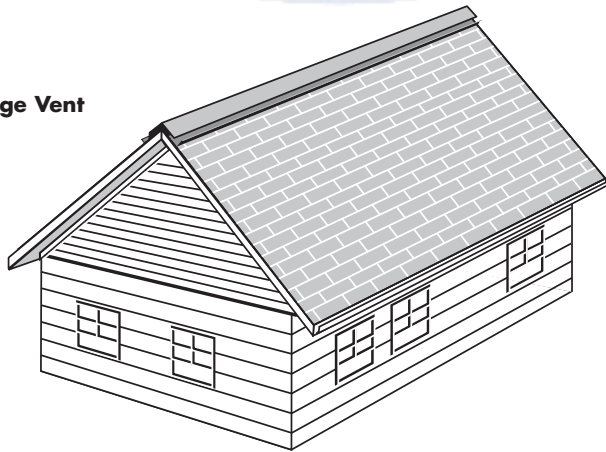
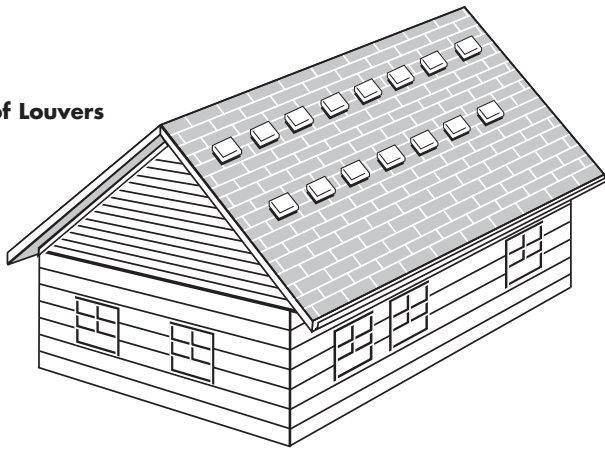
Ridge Vent**Roof Louvers**

Fifteen roof louvers are required to equal the exhaust venting of 42 linear feet of ridge vent. This clearly demonstrates the performance and aesthetic advantages of ridge vents.

It's important to emphasize that the advantages listed above apply only to ridge vents that use an external baffle design. A series of independent tests has concluded that only an external baffle can direct the wind up and over the vent. That's significant, because it's that controlled flow of air that creates the area of low pressure that causes air to be pulled from an attic (see Figure 24 and Figure 25).

Figure 24

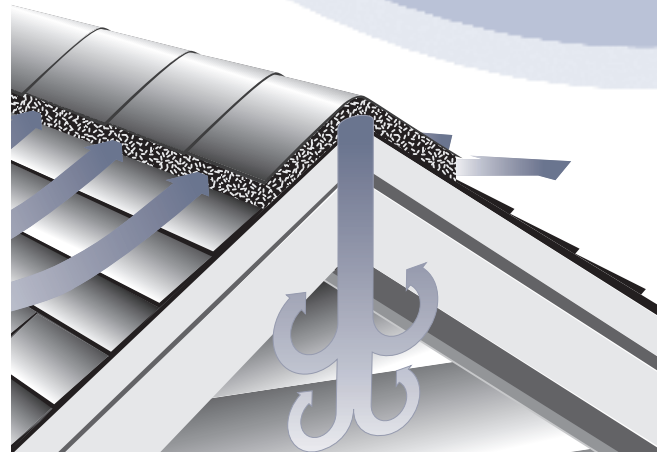

A roll vent with an internal baffle, or without any baffle at all, does not "pull" air from the attic.

Figure 25 **ShingleVent II**

An externally baffled vent "pulls" air from the attic from both sides of the ridge vent.

Guarding against weather and dirt infiltration

When choosing a ridge vent, look for a design that provides maximum protection against rain, snow, dust and insect infiltration.

If installed properly, standard ridge vents with an external baffle produce a steady flow of exhaust air at the ridge. Usually, that airflow protects against weather infiltration. To guard against unusual circumstances where rain and snow infiltration may be possible, advanced products such as Air Vent's Multi-Pitch FilterVent and ShingleVent II include a weather barrier designed to trap moisture before it can enter an attic.

Air Vent also offers variations of its advanced ridge vent design for contemporary homes. For example, Air Vent's Peak FilterVent provides continuous venting at the intersection of a roof peak and vertical wall. Air Vent's Flash FilterVent provides similar continuous venting at points where a roof meets a vertical wall.

Wind turbines

Technically, wind turbines aren't a fixed vent system because they use a moving part to help exhaust air from an attic. That moving part consists of a series of specially shaped vanes that turns wind force into a rotary motion. As the spinning vanes gain velocity, they create an area of low air pressure. That low pressure, in turn, pulls air from an attic.

Although not as effective as ridge vents, wind turbines provide a low-cost alternative in areas where consistent wind speeds of at least 5 mph are typical. Without that minimal wind speed, wind turbines act essentially as roof louvers.

When the wind is blowing, however, wind turbines can be effective air movers.

To provide maximum ventilation benefits, wind turbines, like roof louvers, must be equally spaced along a roof. Otherwise, ventilation will be focused in the area surrounding the wind turbines, allowing hot spots to develop in other areas of the attic (see Figure 26).

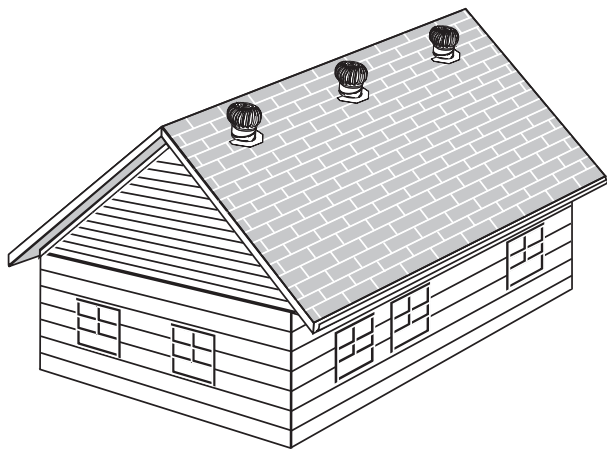
Figure 26

Wind turbines are located near the ridge and are used to exhaust air from the attic.

Power fans

For the most part, a power fan is a motor-driven version of a wind turbine.

A power fan uses the rotary motion of blades to pull air into the attic through the intake vents at the soffit or near the roof's edge and exhausts it out of the attic near the ridge. But instead of using wind power to drive the blades, power fans use electricity to drive high-efficiency motors or sunlight if they are solar powered.

Unlike a wind turbine, however, the effectiveness of a power fan isn't dependent on wind force. Instead, a power fan is turned on and off as needed, automatically, with thermostat and humidistat controls. (In some models, an integral humidistat control is standard; in most models, however, a humidistat is an add-on option. Generally, solar powered fans do not have thermostat or humidistat controls.)

Depending on the size of the motor and the efficiency of the blade design, power fans can move more than 1,500 cubic feet of air per minute (CFM). That high volume of air movement is critical. To ensure adequate ventilation, power fans must provide at least 10 changes of attic air every hour.

Although a power fan can move a large volume of air, a single unit generally cannot "vacuum" all hot air from an attic. Usually, to provide uniform air movement along the underside of the roof sheathing, a series of power fans must be spaced equally along a roof.

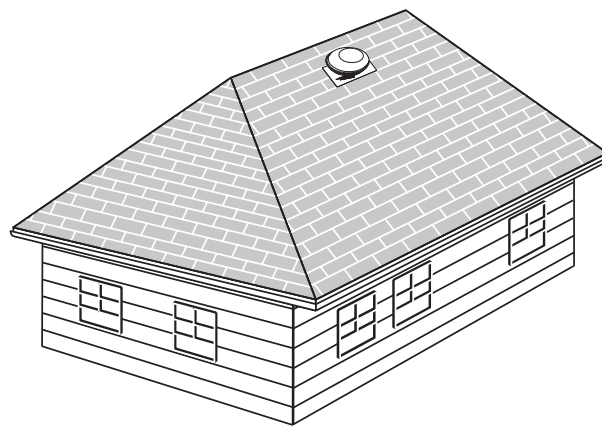
Figure 27

Power fans are used to move large volumes of air – a good option for hard-to-vent hip roofs that have limited horizontal ridge length available for ridge venting.

When evaluating the feasibility of using power fans, it's important to evaluate one factor which is considered to be a major disadvantage: namely, that power fans cannot vent away moisture during the winter unless they are equipped with humidistat controls.

If this is a problem in your climate, it can be solved by using a power fan that has a humidistat control. When that's done, power fans do offer key benefits. For one, they ensure a high volume of airflow, even on days when outside air is virtually still (a common occurrence in inland areas on hot summer days).

In addition, power fans provide ventilation in some circumstances where fixed systems would prove inadequate. Most static exhaust vents in a hip roof application fail to meet ventilation code requirements for high (exhaust) vents, while power fans can provide the air needed to ventilate the attic properly (see Figure 27).

Note: To determine the fan capacity and intake vent requirements when using a power fan, see Section 3.

Section 3: Determining Attic Ventilation Requirements for The Balanced System™

Before the mid-1970s, few people thought about establishing precise requirements for attic ventilation. Homes weren't built as airtight as they are today. If a home had any attic ventilation at all, it usually consisted of some under-eave vents. In some warmer areas of the country, one or more louvers might supplement those vents (the purpose being, as already mentioned, "to catch the breeze"). In especially warm regions, an attic fan might be installed (even though there might not be sufficient intake venting to assure proper functioning).

Even if designers and specifiers had wanted to calculate specific requirements for temperature or moisture reduction, they had little research-based information to guide them.

The Federal Housing Administration tried to close that information gap with minimum property standards for buildings with one or two living units. Since then, other standards have been developed. An example of current minimum requirements for ventilation comes from the 2006 International Residential Code (IRC) Section R806:

R806.1 Ventilation required. Enclosed attics and enclosed rafter spaces formed where ceilings are applied directly to the underside of roof rafters shall have cross ventilation for each separate space by ventilating openings protected against the entrance of rain or snow...

R806.2 Minimum area. The total net free ventilating area shall not be less than 1/150 of the area of the space ventilated except that reduction of the total area to 1/300 is permitted, provided that at least 50 percent and not more than 80 percent of the required ventilating area is provided by ventilators located in the upper portion of the space to be ventilated at least 3 feet (914 mm) above the eave or cornice vents with the balance of the required ventilation provided by eave or cornice vents. As an alternative, the net free cross-ventilation area may be reduced to 1/300 when a vapor barrier having a transmission rate not exceeding 1 perm (5.7×10^{-11} kg/s · m² · Pa) is installed on the warm-in-winter side of the ceiling.

R806.3 Vent and insulation clearance. Where eave or cornice vents are installed, insulation shall not block the free flow of air. A minimum of a 1-inch (25 mm) space shall be provided between the insulation and the roof sheathing at the location of the vent.

Is adequate attic ventilation now assured by following this requirement?

The intent of the requirement, after all, is to establish minimum standards. For example, the IRC permits the net free area requirement to be reduced to the 1/300 ratio in certain situations. That amounts to less than 1/2" of vent area for each square foot of attic floor area, barely enough

to create a flow of air. In addition, this standard assumes a proper balance of exhaust and intake venting. Unfortunately, it's probably safer to assume that assumption rarely holds true.

If you want to install an effective, year-round ventilation system follow the steps below which are based on the 1/150 ratio. This ratio takes into account that today's homes are built with – or remodeled with – materials (doors, insulation, windows, etc.) that are more energy efficient. Consequently, these homes are more airtight and need more attic ventilation.

Calculation requirements for The Balanced System (static vents)

The math involved in calculating ventilation requirements is simple. A pad and pencil are all you need.

Note: The following process is used to calculate requirements for non-powered ventilation systems. If you plan to install a power fan, see calculation instructions on page 14.

1. Determine the square footage of attic area to be ventilated.

To do that, just multiply the length of the attic (in feet) by its width.

Example: For this and the following calculations, we'll assume the home has a 40' by 25' attic area.

Calculation:

$$40' \times 25' = 1,000 \text{ square feet of attic area}$$

2. Determine the total net free area required.

Once attic square footage is known, divide by 150 (for the 1/150 ratio). That determines the total amount of net free area needed to properly ventilate the attic.

Calculation:

$$1,000 \text{ sq. ft.} \div 150 = 6.6 \text{ square feet of total net free area}$$

3. Determine the amount of intake and exhaust (low and high) net free area required.

For optimum performance, the attic ventilation system must be balanced with intake and exhaust vents.

This is a simple calculation: just divide the answer from Step 2 by 2.

Calculation:

$$6.6 \div 2 = 3.3 \text{ sq. ft. of intake net free area and } 3.3 \text{ sq. ft. of exhaust net free area}$$

4. Convert to square inches.

The net free area specifications for attic ventilation products are listed in square inches. Therefore, let's convert our calculation in Step 3 from square feet to square inches. To do this simply multiply by 144.

Calculation:
 $3.3 \text{ sq. ft.} \times 144 = 475 \text{ sq. in. of intake net free area and } 475 \text{ sq. in. of exhaust net free area.}$

5. Determine the number of units of intake and exhaust venting you'll require.

To make these calculations, first refer to the Net Free Area Table below. The table lists the approximate net free area, in square inches, for common intake and exhaust ventilation units.

To perform the calculations, divide the net free area requirement from Step 4 by the appropriate figure from the Net Free Area Table³. For our example, we will use the figures for ShingleVent II and shingle-over The Edge Vent.

Calculation:
 (for 4-foot length of ridge vent)
 $475 \text{ sq. in.} \div 72 = 6.6 \text{ pieces of vent}$
 (or seven 4-foot lengths of ridge vent)

(for 4-foot length of shingle-over intake vent)
 $475 \text{ sq. in.} \div 36 = 13.2 \text{ pieces of vent}$
 (or fourteen 4-foot lengths of shingle-over intake)

Calculations for power fan installations

If you plan on installing a power fan, you can calculate intake and exhaust requirements using the following formulas:

1. Determine the fan capacity needed to provide about 10 to 12 air exchanges per hour.

The formula is:
 Attic square feet x 0.7 = CFM capacity

For example, using the same dimensions as the previous example:

Calculation:
 $1,000 \text{ sq. ft.} \times 0.7 = 700 \text{ CFM}$

³ You can also use the calculation table in the Appendix to determine the amount of ridge vent and intake vent required for an installation.

Note: For roofs with a 7/12 to 10/12 roof pitch, you may want to add 20% more CFM; and for roofs 11/12 pitch and higher add 30% more CFM to handle the larger volume of attic space.

2. Determine the amount of intake venting required. The formula is:

CFM rating of fan ÷ 300 = square feet of intake ventilation needed.

Calculation:
 $700 \div 300 = 2.3 \text{ square feet}$

To turn that figure into square inches multiply by 144.

Calculation:
 $2.3 \times 144 = 331 \text{ square inches of net free intake area}$

To find the number of intake vents required, use the Net Free Area Table below (see "Low Vents – Intake").

Net Free Area Table

Type of Vent	Net Free Attic Vent Area (sq. in. – approximate) [†]
High Vents – Exhaust	
FilterVent (8' length)	144 (18 per ft.)
ShingleVent II (4' length)	72 (18 per ft.)
Roof louver	50
Wind turbine (12")	112
Rectangular gable louvers	
12" x 12"	56
12" x 18"	82
14" x 24"	145
18" x 24"	150
24" x 30"	324
Low Vents – Intake	
16" x 8" undereave	56
16" x 6" undereave	42
16" x 4" undereave	28
Continuous Soffit Vent (8' length)	72 (9 per ft.)
Vented Drip Edge (10' length)	90 (9 per ft.)
Shingle-over intake The Edge Vent (4' length)	36 (9 per ft.)
Perforated aluminum soffit [†]	
One square foot	14
Lanced aluminum soffit [†]	
One square foot	4-7

[†]Be sure to check specifications for individual products to determine actual net free vent area.

Appendix: Ridge Vent/Intake Vent Calculator for Standard Gable Attic*

*An electronic version of this calculator is available @ www.airvent.com.

To use this calculator, first find the total square footage of the attic floor area. Round your calculations up to the next highest number (see Appendix A).

Then look across to the number under the Minimum Length of Ridge column. That tells you the total linear feet of ridge vent required using the 1/300 minimum code requirements. *Note: Because today's tighter homes require more airflow, the 1/150 ratio is also included in Appendix A.*

To balance your ridge vent system, find the length of the ridge and follow the column to the right for required intake vents (see Appendix B).

Appendix A

Ventilation Requirements

Attic Square Footage	Minimum Length of Ridge	
	at 1/300 ratio	at 1/150 ratio
1200	16	32
1500	20	40
1800	24	48
2100	28	56
2400	32	64
2600	36	72
3000	40	80
3300	44	88

Note: Calculations are based on ShingleVent II and Multi-Pitch FilterVent which provide 18" of net free area per linear foot.

Appendix B

Balancing Your Ridge Vent System

Length of Ridge	Linear Feet of The Edge Vent shingle-over intake	Number of Undereave Vents		
		16"x8"	16"x6"	16"x4"
15'	30	5	6	10
20'	40	6	9	13
30'	60	10	13	19
40'	80	13	17	26
50'	100	16	21	32
60'	120	19	26	39
70'	140	23	30	45
80'	160	26	34	51
90'	180	29	39	58

Note: FHA requirements and most building codes state the minimum required net free area. This minimum ventilation area may not be enough to effectively ventilate the attic to prevent moisture damage and cool the attic enough in the winter to prevent ice dams.

A note on code compliance:

When installed properly, all Air Vent products mentioned in this publication comply with the net free area requirements of nationally recognized model codes, including those written by the International Code Council. In addition, the vents have product evaluation approvals from Dade County, Florida, ICC and TDI.

Please call 1-800-AIR-VENT to obtain code body information for a particular Air Vent product.

PROVEN PERFORMANCE THROUGH RESEARCH.

Air Vent Inc., is dedicated to improving the performance of attic ventilation products through research, product development and testing. We are also dedicated to sharing this information with the marketplace to help building professionals improve their knowledge and understanding of how to specify and install a ventilation system. Test results prove that our ongoing commitment has resulted in enhanced performance. As we look to the future, we will continue our efforts toward the advancement of ventilation technology.

For more information about ShingleVent®II, our complete line of electric and solar powered fans, our new The Edge™ Vent shingle-over intake and other Air Vent products, please call 1-800-AIR-VENT (247-8368) or visit our website at www.airvent.com.

Glossary

The Balanced System™

Equal amounts of intake net free area ventilation at the eaves or roof's edge and exhaust net free area ventilation at or near the ridge.

Bernoulli Effect

A phenomenon whereby low pressure resulting from wind passing over a structure or object creates a pulling or lifting action.

CFM

Cubic Feet of air moved per *Minute*. All motorized vents have a CFM rating that defines the vent's capacity to move air. The higher the CFM number, the greater the vent's capacity.

Cold Roof

The condition in which the roof temperature is equalized from top to bottom. An equalized roof temperature can help eliminate the conditions that can lead to the formation of ice dams.

Condensation

The change of water from vapor to liquid when warm, moisture-laden air comes in contact with a cold surface.

Conduction

Flow of heat directly through a solid material; responsible for most heat loss or gain in a residence.

Convection

Transfer of heat by air currents, i.e., gravity, hot air furnace.

Deck

The surface, installed over the supporting framing members, to which the roofing is applied.

Dormer

A framed window unit projecting through the sloping plane of a roof.

Drip Edge

A corrosion-resistant, non-staining material used along the eaves and rakes to allow water run-off to drip clear of underlying construction.

Eaves

The horizontal, lower edge of a sloped roof which typically overhangs the walls.

Exhaust Vent

An outlet or opening installed high on the roof near the ridge or in the gable for the purpose of ventilating the underside of the roof deck.

External Wind Baffle

The built-in wing or lip on a ridge vent that deflects wind up and over the vent creating the Bernoulli Effect that enhances airflow performance by pulling or lifting the air out of the attic. It also deflects weather elements over the vent away from the attic.

Flashing

Pieces of metal or roll roofing used to prevent seepage of water into a building around any intersection or projection in a roof, such as vent pipes, chimneys, adjoining walls, dormers and valleys. Galvanized metal flashing should be minimum 26-gauge.

Gable

The upper portion of a sidewall that comes to a triangular point at the ridge of a sloping roof.

Gable Roof

A type of roof containing sloping planes of the same pitch on each side of the ridge. Contains a gable at each end.

Gambrel Roof

A type of roof containing two sloping planes of different pitch on each side of the ridge. The lower plane has a steeper slope than the upper. Contains a gable at each end.

Gutter

A shallow channel or conduit of metal or wood set below and along the eaves of a house to catch and carry off rainwater from the roof.

Hip

The inclined external angle formed by the intersection of two sloping roof planes. Runs from the ridge to the eaves.

Hip Roof

A type of roof containing sloping planes of the same pitch on each of four sides. Contains no gables.

Ice Dam

A collection of melted snow that refreezes, typically at the projecting eave of a sloping roof. The ice dam causes the water from melting snow to back up under roof shingles.

Intake Vent

An inlet or opening installed in the soffit/under-eave area or roof's edge for the purpose of ventilating the underside of the roof deck.

Internal Weather Filter

An untreated, unwoven fiberglass material inside ShingleVent II and FilterVent ridge vents that provides extra weather protection from wind-driven rain, snow and dust.

Mansard Roof

A type of roof containing two sloping planes of different pitch on each of four sides. The lower plane has a much steeper pitch than the upper, often approaching vertical. Contains no gables.

Net Free Area

The total unobstructed area through which air can pass through a vent; generally measured in square inches. All nonpowered vents have a Net Free Area rating.

Overhang

The portion of the roof structure that extends beyond the exterior walls of a building.

Pitch

The degree of roof incline expressed as the ratio of the rise, in feet, to the span, in feet.

R-Value

Thermal resistance, a measure of a material's or a construction's ability to retard heat flow. R-Values in a series of materials can be added to determine a construction's total thermal resistance.

Radiant Heat

Heat transferred from one body to another which are not in contact (i.e., from the sun to a roof).

Rafter

One of a series of structural members of a roof, designed to support roof loads. The rafters of a flat roof are sometimes called roof joists.

Rake

The inclined overhang of a gable roof.

Ridge

The horizontal line at the junction of the top edges of two sloping roof surfaces. The rafters of both slopes are nailed to a board at the ridge.

Sheathing

Exterior grade boards used as a roof deck material.

Shed Roof

A roof containing only one sloping plane. Has no hips, ridges, valleys or gables.

Slope

The degree of roof incline expressed as the ratio of the rise, in inches, to the run, in feet.

Soffit

The finished underside of the eaves.

Square

A unit of roof measurement covering a 10 ft. by 10 ft. roof area, or 100 square feet of roof area.

Thermal Effect

The inherent property of warm air to rise, also known as thermal buoyancy.

Vapor Diffusion

The process in which water vapor naturally travels from high-humidity conditions to low-humidity conditions; for example, from the living space into the attic.

Vapor Retarder

Any material used to prevent the passage of water vapor. Applied to insulation or other surfaces, it retards vapor travel to regions of low temperature where it may condense. A material is considered a vapor retarder if it has a perm rating of 1 or less (the lower the perm, the better the vapor retarder). Examples: Kraft facing on insulation, foil facing on insulation.

Vent

Any device installed in the roof, gable or soffit for the purpose of ventilating the underside of the roof deck. Any outlet for air that protrudes through the roof deck such as a pipe or stack.

Waterproofing Shingle Underlayment (WSU)

A special self-adhering waterproofing shingle underlayment designed to protect against water infiltration due to ice dams or wind-driven rain.



1-800-AIR VENT (247-8368)
www.airvent.com

4117 Pinnacle Point Drive, Suite 400
Dallas, TX 75211

A GIBALTAR INDUSTRIES COMPANY 

©2008 Air Vent, Inc.
AVI004 -1/08